

sewoo

Aroot Co., Ltd.

28-6, Gajangsaneopdong-ro, Osan-si, Gyeonggi-do, 18103, Republic of Korea
TEL +82-31-8077-5000 / FAX +82-31-624-5310 / <http://www.miniprinter.com>

sewoo



MODEL : LK-P34

MOBILE PRINTER(Wi-Fi & Bluetooth)

All specifications are subject to change without notice

Following information shall be included in the manual

Information to User;

Caution:

the user that changes or modifications not expressly approved by the J. STEPHEN Lab., Ltd.responsible for compliance could void the user's authority to operate the equipment.

NOTE:

This equipment has been tested and found to comply with the limits for a Class B digital device, pursuant to part 15 of the FCC Rules. These limits are designed to provide reasonable protection against harmful interference in a residential installation. This equipment generates, uses and can radiate radio frequency energy and, if not installed and used in accordance with the instructions, may cause harmful interference to radio communications. However, there is no guarantee that interference will not occur in a particular installation.

If this equipment does cause harmful interference to radio or television reception, which can be determined by turning the equipment off and on, the user is encouraged to try to correct the interference by one or more of the following measures:

- Reorient or relocate the receiving antenna.
- Increase the separation between the equipment and receiver.
- Connect the equipment into an outlet on a circuit different from that to which the receiver is connected.
- Consult the dealer or an experienced radio/TV technician for help.

Responsible Party;

The responsible party for Supplier's Declaration of Conformity must be located within the United States, so you have to include following information in manual.

**This device complies with part 15 of the FCC Rules.
Operation is subject to the following two conditions.**

- 1) This device may not cause harmful interference, and
- 2) This device must accept any interference received, including interference that may cause undesired operation.

Tim Kloeker

19700 S Vermont Ave Ste 200 Torrance, CA 90502 | USA
NA_Sales@miniprinter.com

Victor Almazan

Paseo de la Reforma No. 265 Piso 2.Oficina SBC. Col.
Cuauhtémoc, C.P. 06500 Ciudad de Mexico | Mexico
LA_Sales@miniprinter.com



**Risk of explosion if battery is replaced by an incorrectly type.
Dispose of used battery according to the local disposal instructions.**



**Disposal of Old Electrical&Electronic Equipment(Applicable in
the European Union and other European countries with separate
collection systems)**

This symbol on the product or on its packaging indicates that this product shall not be treated as household waste. Instead it shall be handed over to the applicable collection point for the recycling of electrical and electronics equipment. For more detailed information about recycling of this product, please contact your local city office, your household waste disposal service or the shop where you purchased the product.

Safety Precautions

For better safety and reliability, adhere to the following precautionary measures.

Read and follow the instructions carefully before operation of the product.

Indication



Prohibition



Must follow



Do not disassemble



Unplug the power from the outlet



Grounding to prevent electric shock



Do not handle the product with wet hands



WARNING

Failure to follow these instructions could result in fire, electric shock, other injuries, or property damage.



Do not pull or touch the power plug with wet hands.

Potential risk of electric shock or fire



Do not bend the wire and do not allow the wire to be pinched or crushed by heavy objects.

Potential risk of electric shock or fire

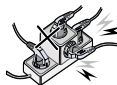

Do not overload an electrical outlet.

Potential risk of electric shock or fire

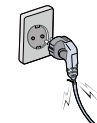

If a power plug is broken or a plug is cut or worn, do not use it.

Potential risk of electric shock or fire





WARNING

Failure to follow these instructions could result in fire, electric shock, other injuries, or property damage.



Do not unplug the power cable to turn off the product.

Turn off the power using the power button



Do not disassemble, repair or modify the product.

Potential risk of malfunction, electric shock, or fire. When the product needs to be repaired, please contact your reseller



CAUTION

Failure to follow these instructions could result in fire, electric shock, other injuries, or property damage.

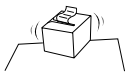

Do not install the product on an unstable or inclined surface.

May cause damage or injury

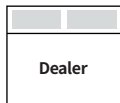

If the product needs to be repaired, please contact your reseller.

Potential risk of fire or unit malfunction



Keep product away from the water and other material.

Potential risk of fire or unit malfunction

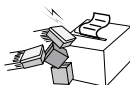

Avoid excessive shock or drops.

Potential risk of fire or property damage



Table of Contents

Product Overview	
1. Unpacking	6
2. Product Overview	7
3. AMC(Advanced manual cutter) Button	8
4. Control Panel Usage	9
Set Up	
5. Paper Installation	10
6. Battery	11
6-1. Battery Installation	11
6-2. Battery Removal	12
6-3. Battery Charging	13
6-4. Charging Cradle (OPTIONAL)	14
7. Belt Strap	15
8. Self Test	16
Peripheral Connection	
9. Peripheral Connection	18
9-1. Bluetooth Connection (Optional)	18
9-2. Wi-Fi Connection (Optional)	18
9-3. NFC Connection (Optional)	19
9-4. Interface Cable connection	20

Maintenance

10. Cleaning the Printer	21
--------------------------	----

11. JAM Error	22
---------------	----

Specification

12. Roll Media Specification	23
------------------------------	----

13. Black Mark	24
----------------	----

14. Printer Specification	25
---------------------------	----

15. Utilities	27
---------------	----

16. S/W	28
---------	----

1. Unpacking

Standard



Printer

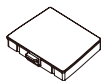

Battery

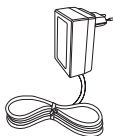

Charger

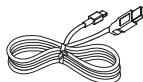

USB Cable

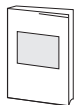

Quick Manual



Belt Strap

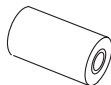

Roll Paper

Optional



AC Cord

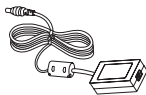

Adaptor



Shoulder Strap

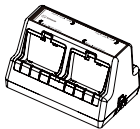

4BC-XX(Charging Cradle)

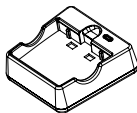

Battery Cradle(Charging Cradle)

2. Product overview

Front

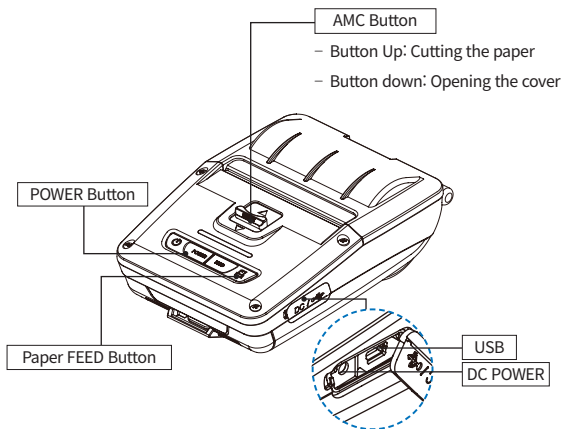

Rear

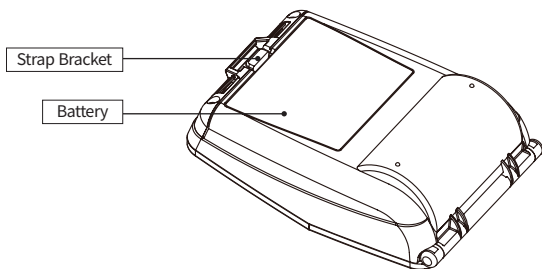

3. AMC(Advanced Manual Cutter) BUTTON

AMC function gives the convenient way for users to cut papers.

AMC Button

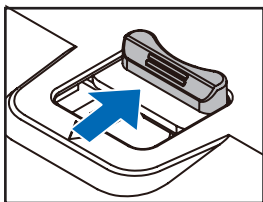
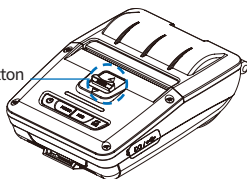

Button Up

Press the button up to cut the paper.

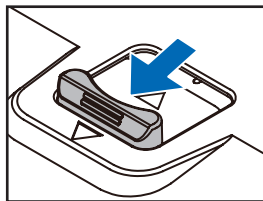

Button Down

Press the button down to open the cover.
Please press the button down and open the cover in situations such as cleaning the head, replacing a paper, and having a paper jam error.

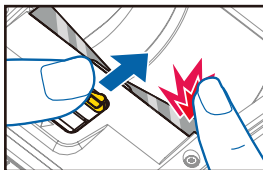





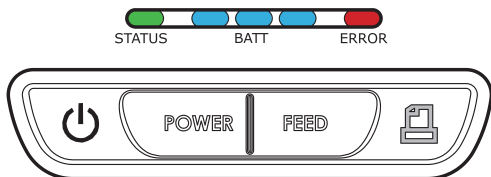

⚠ CAUTION

Please stay your fingers away from the printer head after pressing up the AMC button with cover open.

There is the risk of finger injury due to a projecting cutter blade.

4. Control panel usage



Button	Name	function
	Power Button	<ul style="list-style-type: none"> - This button is used to turn the printer on and off. - When the printer is off, press this button for approximately 3 seconds and the printer will power on. When you press this button while the printer is powered on, the printer will turn off.
	Paper Feed Button	<ul style="list-style-type: none"> - This button can be used to manually feed the paper. - Additionally, this button is also used to initiate self-tests and Hexadecimal Dumping. 01 Refer to the Self Test section of this manual for information regarding self-tests. 02 Refer to the Note in Self Test section of this manual for information regarding Hexadecimal Dumping.
	Battery Status Lamp	<ul style="list-style-type: none"> - If the Batt LED is lit, the battery is fully charged. - If you can hear a beeping sound and LED light is turned off, the battery is at the lowest level. - If the battery is not charged at all, the printer turns off automatically.
	Error Lamp	<ul style="list-style-type: none"> - If the red light is turned on, there is no paper or the paper cover is open.
	LINK/ Power Light	<ul style="list-style-type: none"> - LINK: LED BLINK - POWER ON: GREEN LED ON - POWER OFF: LED OFF

5. Paper Installation



CAUTION
Make sure to be careful of
the HOT head

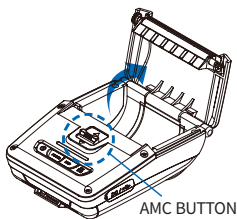

AMC BUTTON

Press the AMC button down to open
the paper cover.

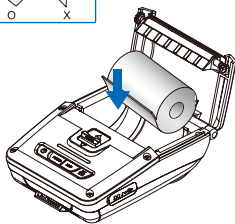
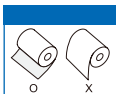

Place the paper roll as shown. Make sure
the paper is placed in the right direction.



CAUTION
Please make sure you hear the
closing sound of the upper cover.

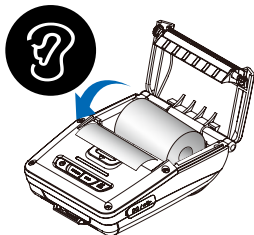

Pull a short length of paper out of the
printer and close the cover.



CAUTION
If the cover is not shut down completely,
the printer may not work properly



Press the AMC button up to cut the
unnecessary paper.

6. Battery

6-1. Battery Installation

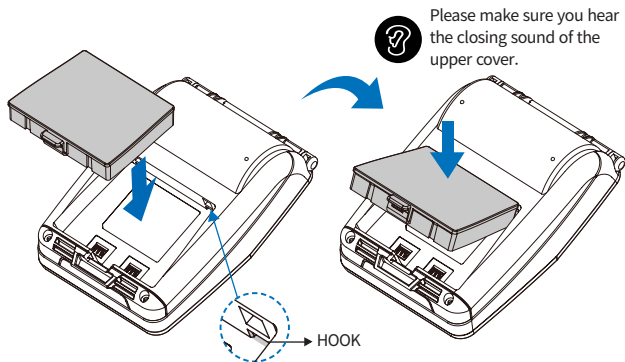

- 1 Align battery hook as shown in the picture.
- 2 Push the battery into the printer until it locks in place.

✓ NOTE

As the battery is not charged at the time of your purchase, charge the battery prior to using the printer.

6-2. Battery Removal

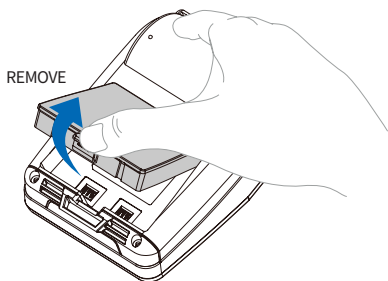

Remove the battery as shown.

6-3. Battery Charging

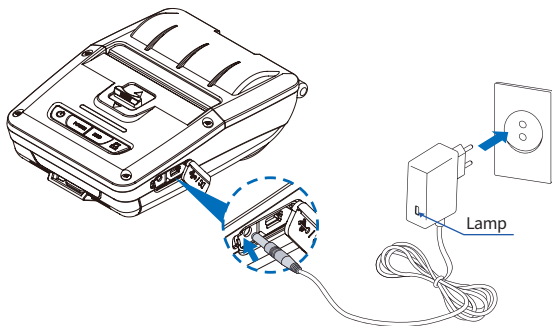

- 1 Make sure the printer is turned off.
- 2 After opening the DC JACK cover, connect the DC JACK to the printer.
- 3 Plug the power cord into the electrical outlet.

Status	charging	charging complete
Charging Lamp	Red	Green

✓ NOTE

- 01 If the charger provided by the manufacturer is not used, the printer can be damaged, and the manufacturer is not liable for the consequential damage.
- 02 Before removing the battery, make sure that power is turned off.
- 03 The printer does not work when only connected to the charger.
- 04 The battery needs to be installed to operate the printer.
- 05 While charging, do not turn on the power.
- 06 Do not operate the printer while charging the battery.
- 07 Do not connect the charger while the printer is operating.

6-4. Charging Cradle Optional

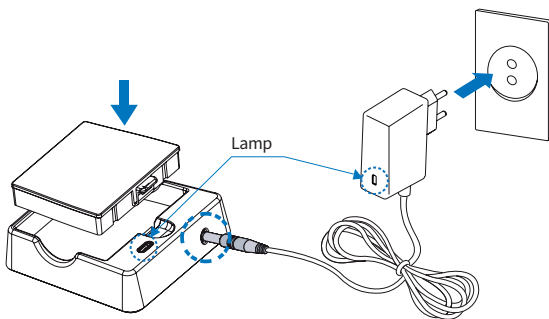

- 1 Insert the battery into the battery charger as shown above.
- 2 Connect the DC JACK to the electrical outlet.
- 3 Plug the power cord into the electrical outlet.
- 4 Once the charging is completed, remove the battery from the charger.

The charging status LED

Status	charging	charging complete
Charging Lamp	Red	Green

NOTE

In the case the battery is not inserted properly, the red LED will blink. Remove and reinsert the battery.

7. Belt Strap



Prepare the belt strap.

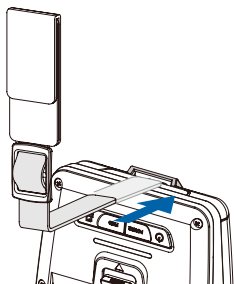

Put the strap into the strap bracket hole as shown.

1 2
3 4

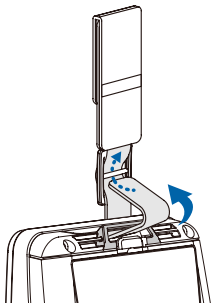

Turn the strap and printer over and put the strap into the hook as shown.

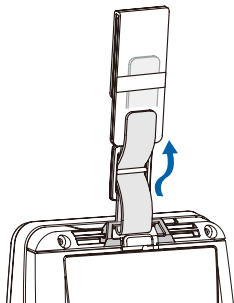

Adjust the strap length for the user's convenience.

8. Self Test

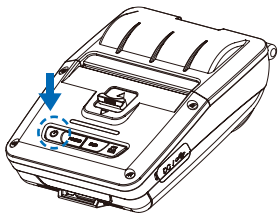

Turn off the power by pressing the power button for approximately 3 seconds.

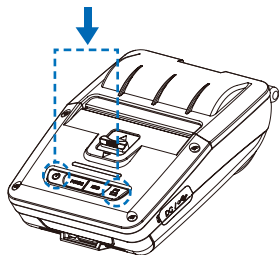

While you are holding the FEED button, press the power button.

1 2
3



The self-test will print.

✓ NOTE

- 01 To enter hex dump mode, press the FEED button once more.
- 02 If the FEED button is not pressed, the self-test will automatically finish after 3 seconds.

Self-Test Printout Sample

SEWOO, LK-P34

Printer Configuration Info.

F/W Version : v1.00
FontRom Version : v1.3
BM(Adj) : 151(148)
Sensor Mode: [BAR]
Battery : 7.9V(796),offset:0
Timeout(Sleep) : 60 sec
Ext' Flash : Exist
H/W Version : v2.0
SDRAM : 8MB
Linerless : Disabled

Emulation Configuration Info.

Emulation : ESC/POS
Print Density : Normal(0)
Language : Korean
한글완성형
Top of Form : 0
Top Margin : 0
Left margin : 0

USB Interface

Version 2.0 Full speed
compliant
Product String : LK-P34

Bluetooth Interface

Version : v0184
Device Name : SW_61fd
Mode : SPP_IAP_MODE
Pairing Info : SSP_MODE
Class Type : PRINTER_CLASS
Auto connection: Enabled
BLE : Disabled
Address : 8B:8b:0f:4e:61:fd



```
*****  
! "#$%&'()*+,-./0123456789:;<=>?  
@ABCDEFGHIJKLMNPQRSTUvwxyz[\]_`  
'abcdefghijklmnopqrstuvwxyz{|}~  
*****  
가 나 다 라 마 바 사 아 자 차  
*****
```

```
*****  
Press FEED button to  
enter HEX-DUMP mode.  
*****
```

Upon initial installation or for troubleshooting, you can run the diagnostic test to get information about:

- Firmware version, emulation, codepage, sensor settings, interface settings, etc.

If no issues are found with the diagnostic test, examine other devices and software.

The diagnostic test is working independently of devices and software.

※ Motor protection from being overheated

To prevent the motor from overheating, stop the printer for at least 30 seconds after continuously printing 1.5 meters.

9. Peripheral Connection

This product can communicate with other devices via Bluetooth, Wi-Fi, or a communication cable.

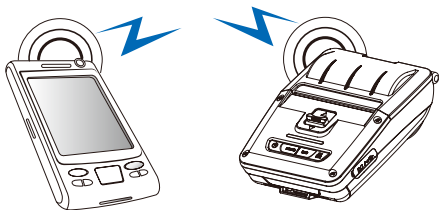

9-1. Bluetooth Connection *Optional*

- 1 The Printer can be connected to devices equipped with Bluetooth communication capabilities (PDAs, PCs, etc.).
- 2 Use the Bluetooth connection function supported by your device to connect to the printer.

✓ NOTE

- This model supports Numeric Comparison function.
- Please refer to the configuration manual for details.

9-2. Wi-Fi Connection *Optional*

- 1 The Printer can be connected to devices equipped with Wi-Fi communication capabilities (PDAs, PCs, etc.).
- 2 Use the Wi-Fi connection function supported by the device to connect to the printer.

✓ NOTE

- Please refer to the configuration manual for details.

9-3. NFC Connection Optional

The printer can be connected to devices equipped with NFC communication capabilities.

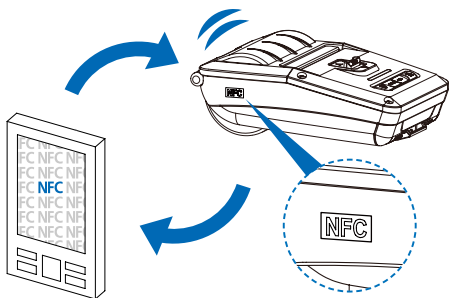

Use the NFC connection function supported by the device to connect to the printer.

✓ NOTE

- Please refer to the configuration manual for details.
- NFC is only compatible with Bluetooth.

9-4. Interface Cable Connection

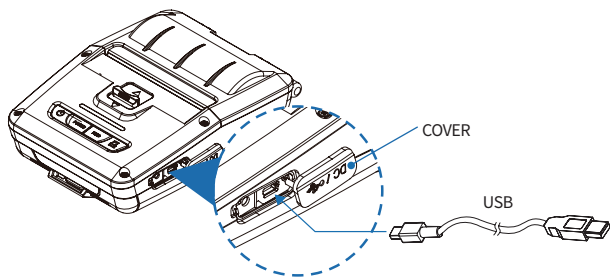

- 1 Flip over the connector cover and connect USB cable to the printer connector.

✓ NOTE

Only use cables included with the printer. (USB)

- 2 Connect the interface cable to the USB port of the device (PDA, PC, etc.).

10. Cleaning the Printer

If the interior of the printer is dusty, printing quality can be reduced.

In this case, follow the instructions below to clean the printer.

✔ NOTE

- 01 Make sure to turn the printer power off prior to cleaning.
- 02 Regarding printhead cleaning, as the printhead gets very hot during printing, turn off the printer power and wait approximately 10 minutes before cleaning.
- 03 When cleaning the printhead, take care not to touch the heated portion of the printhead. The printhead can be damaged by static electricity.
- 04 Take care not to allow the printhead to become scratched and / or damaged in any way.

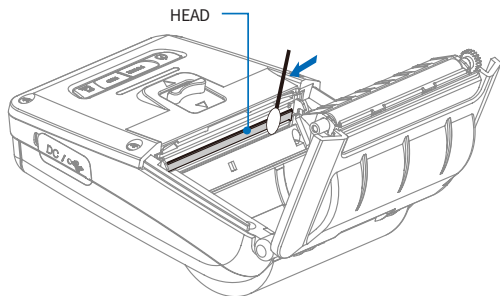

- 1 Use an applicator swab moistened with an alcohol solution to clean the printhead and remove any dust.
- 2 Once the cleaning is completed, wait a few minutes before inserting the paper roll into the printer.

✔ Preventing Overheating

To prevent the motor from overheating, stop the printer for at least 30 seconds after continuously printing 1.5 meters.

11. JAM Error

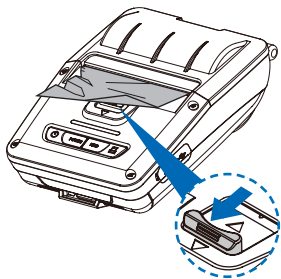

When you face with a paper jam error, please press the button down to open the printer cover.



CAUTION
Make sure to be careful of the HOT head.

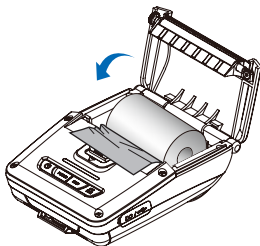

Please remove the paper.

1 2
3



NOTE
Please make sure you hear the closing sound of the upper cover.



NOTE
If the cover is not shut down completely, the printer may not work properly



After removing, close the cover. The printer will work normally.

12. Roll Media Specification

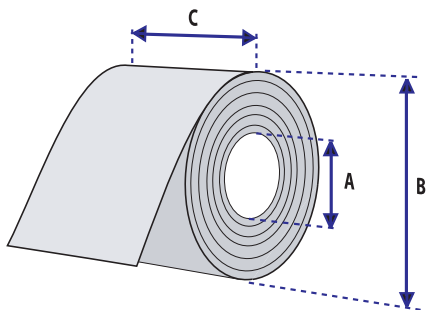

Core	
Diameter (A)	12.5 mm
Roll	
Max.Diameter (B)	50 mm
Max.Media Width (C)	80 mm
Min.Media Thickness	0.06 mm



Protect the printhead from sand, grit, and other hard particles during printing and storage. Keep the cover closed.
Even very small foreign particles may cause severe harm to the printhead.

13. Black Mark

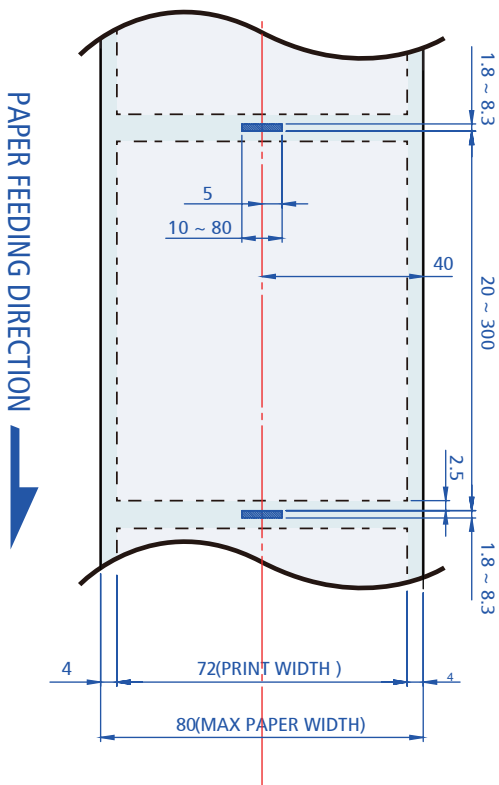

14. Printer Specification

Printing Method		Direct Thermal
Printing Speed		100mm/s
Resolution		203 DPI
Character		Font A(12×24), Font B(9×17), Asian Font(KOR,JPN,CHN-GB2312,CHN-Big5), Font0/1/2/4/5/6/7, Resident TTF, Downloadable TTF, FontA~H, FontGS, Resident TTF(Font0), Font 1~8
Barcode	1D	EAN-8,EAN8(+2+5), EAN-13, EAN13(+2+5), Codabar, Code11, Code39, Code93, Code128, ITF, LUPC-A(+2+5), UPC-E, UPC-E(+2+5), Planet, UPC-A etc
	2D	PDF417, QR, Maxicode, RSS14, TLC39, Datamatrix, Aztec, MicroPDF417
Emulation		ESC/POS, CPCL, ZPL Command compatible
Driver		Windows Driver(XP ~, Server2003 ~), Window CE & Mobile Driver & SDK (CE 4.2~, Mobile 5.0~), Linux Driver, Mac Driver, OPOS Driver, JavaPOS Driver, iOS SDK, Android(6.0 ~) SDK
Sensor		Black mark, Paper end
Paper	Paper type	Thermal Receipt
	Width	80mm (PAPER GUIDE : 58mm)
	Thickness	0.06mm
	Roll Max Diameter	Max. Ø 50mm
	Roll Core	12.5mm ± 0.5mm

Interface	Standard	USB
	Option	Wi-Fi(802.11a/b/g/n), Bluetooth Smart Ready(Bluetooth4.2+BLE + NFC Tag)
Battery Charger	Input	AC100~240V, 50/60Hz
	Output	8.4V , 800~1400mA
Battery	Type	Li-ion
	Output	7.4V, 2000mAh
	Charging time	2.7Hrs (61Hrs stand-by)
Cutter		AMC(Advanced Manual Cutter)
Size (W x L x D)		107.5 x 145 x 56 mm
IP		IP54
Weight		422g (with Battery)
Temperature	Operation	-10 ~ 50°C
	Storage	-20 ~ 60°C
Humidity	Operation	10 ~ 80%
	Storage	10 ~ 90%

15. Utilities

The following utilities and concerned manual can be found on the QR or homepage.

No.	Name	Description
1	Configuration Tool	This is a utility that allows you to set printers by interface. Detailed settings such as Wi-Fi, Ethernet, and COM ports can be configured.
2	Download Tool(F/W)	Printer F/W and Font Download are available, and BT, Wi-Fi module F/W Download is supported. – P22, 20II can download ICR F/W. – BT/Wi-Fi Download function is not supported for P400, P21, P25. – P400 supports SD Card Download function instead of Font Download.
3	NVUpload (ESC/POS)	With NVUpload running on Windows OS, you can upload and remove the bmp file as Logo in the printer's flash memory, and print test is possible.
4	Bitmap Font Download(CPCL)	It is a utility that allows you to change Windows Fonts stored on your PC into Bitmap Fonts for use on the printer.
5	LabelMaker(CPCL)	This program is for label form design and designed label printing.
6	Android Utility (Sewoo M_Utility) (ESC/POS)	It is a utility app that prints text, barcodes, images, etc. through Bluetooth and Wi-Fi communication, and able to printer settings.

16. S/W

We provides SDK, Driver, etc. as follows to respond to various S/W usage environments.

You can download this S/W from the homepage.

No	Name	Description
1	Windows Driver	This is an install program used to print a Mobile printer in Windows OS.
2	Linux Driver	This is the Cups Driver used to print a Mobile printer in the Linux environment.
3	OPOS Driver (ESC/POS)	This is a driver that controls Mobile printers using the OPOS standard. It can be used after initial setting(Mobile Printer&MSR) using the setting tool.
4	JavaPOS Driver (ESC/POS)	JavaPOS driver is an interface standard for POS software written in Java, and can be used in Mobile Printer when printing a receipt.
5	Mac Driver	This is the Cups Driver used to print a Mobile printer in the Mac OS environment.
6	Android Plugin (Sewoo Print Service Plugin) (ESC/POS)	This is a print service plug-in that allows you to print documents, images, and web pages without installing additional apps.
7	Windows SDK	This is library for communication and data output with Mobile printer in Windows OS.
8	Android SDK	This is library for communication and data output with Mobile printers in Android OS.
9	iOS SDK	This is library for communication and data output with Mobile printers in iOS.



QR Page